



EMERGENCY



E-MEDICAL



INDUSTRY



DATACENTRE



TRANSPORT

NextEnergy



ONLINE



Tower



ECO LEVEL



USB plug



Service 1st start



Flywheel compatible



Supercaps UPS



Lithium compatible



SmartGrid ready



3:3 250-800 kVA/kW

NextEnergy

HIGHLIGHTS

- **Efficiency up to 97% in double conversion**
- **kW = kVA (pf 1) up to 40 °C**
- **Transformer-free UPS**
- **Full front access, back-to-back install**
- **Active Filter Mode (ACTIVE ECO)**
- **Colour LCD Touch Screen**
- **Peak shaving**

The Riello UPS NextEnergy is the latest UPS series designed for mission critical applications as data centres, communication networks, commercial and industrial installations.

The three-phase UPS offers transformer-free double conversion technology VFI SS 111, with integrated IGBT three-level design. NextEnergy is designed to offer unsurpassed performance and meets the power requirements of tomorrow. NextEnergy is fully scalable to evolve with growing business demands. It offers the highest level of power availability as well as reduced TCO, minimum energy consumption and CO₂ emissions. Its unity power factor and easy system upgrading make it the ideal solution for the business continuity of any IT application. Thanks to its fault tolerant architecture, concurrent maintainability

and hot scalability, NextEnergy guarantees continuous operation and premium protection for your customers' business.

ZERO IMPACT SOURCE AND PEAK DEMAND MANAGEMENT

NextEnergy is designed with the latest technology to prevent disturbances on the mains and is able to "clean" the power from e.g. harmonics generated by non-linear loads. The input AC/DC converter is based on the IGBT rectifier design using the latest 3-level technology.

The key features are:

- Input current distortion <3%;
- Input power factor 0.99;
- Power walk-in function that ensures progressive rectifier start up;
- start up delay function, to restart the rectifiers when mains power is restored.

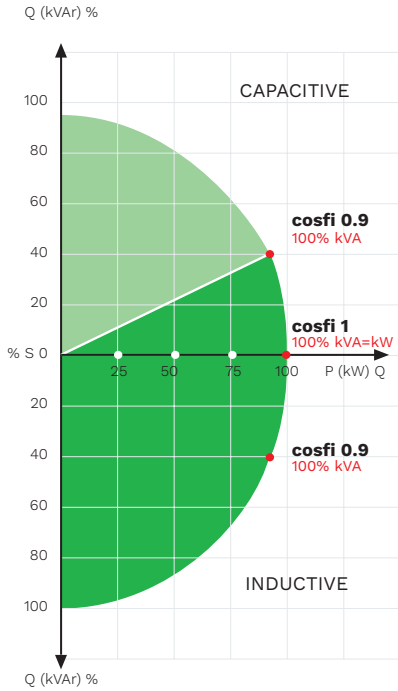

OUTSTANDING PERFORMANCE

- The latest technology of NextEnergy and the careful selection of high-quality components help to achieve first-class performance such as unity power factor ($kVA = kW$) and the capability to supply capacitive loads, which are very common in most Data Centres, without any power derating up to 40 °C;
- Outstanding system efficiency up to 97% in ON LINE double conversion mode, increasing to 98.5% in ACTIVE ECO and 99% in STANDBY Mode;
- Specific attention has been given to the ventilation system to ensure the best operational level and long lifetime. This is possible thanks to the automatic fan speed control which constantly adjusts to the specific load level, the fan failure alarm and the fan redundancy architecture;
- NextEnergy is capable to work at very high ambient temperature, over to 40 °C. The UPS is designed with consistent safety margins granting operation up to 55 °C (condition apply).

the required backup time. The battery charging and discharging is assured by the STEP-UP/STEP-DOWN converter which means that when the batteries are charged and the mains is available, the battery is no longer connected to the supply. This means the ripple current is practically zero which leads to a significant improvement in battery life.

FLEXIBLE BATTERY STORAGE

NextEnergy offers complete freedom to choose the best energy storage device for each type of installation or application. The variety of the charging methods in conjunction with the flexibility offered by the power electronics and the decades of field experience allow to use NextEnergy in conjunction with all the most common type of battery technologies available in the market like VRLA, AGM, GEL, NiCd but also with other type of energy accumulators as Li-ion Battery solutions. For short back-up time from some seconds up to a couple of minutes NextEnergy is released to work also with SuperCapacitors or FlyWheels, a very reliable technology for such applications.

PEAK SHAVING FUNCTION

Thanks to the possibility to set the maximum input power (kW or kVA), NextEnergy can be installed into AC supply systems with limited power availability such as a diesel generator or contractually reduced power sources and then supply the additional power required using the batteries (Peak Shaving function).

NextEnergy offers 3 peak shaving operation modes:

- **Static:** the NXE input power is programmed at commissioning time;
- **User Remote control:** the user decides when reduce the input power of the UPS via commands;
- **Dynamic:** the peak shaving works automatically as per the site conditions.

SMART BATTERY MANAGEMENT (SBM)

The battery system is the energy reserve in every UPS installation and consequently a fundamental asset in every power continuity plan to ensures the correct operation in case of mains failure. This asset must be carefully managed. NextEnergy includes all the latest features supervise, to prolong the battery life and keep the battery working efficiently, as well as advising users about any potential problem. In addition, NextEnergy allows flexibility on the number of battery cells to choose the most cost-effective solution for

CAPACITY AND INSTALLATION FLEXIBILITY

NextEnergy is designed to guarantee maximum cost savings (TCO) and flexibility of installation to adapt to every need and situation.

- The UPS ventilation is from the front of the cabinet to the top so no additional rear clearance is required, allowing vast range of layouts configurations, whether it be a straight row, back to wall or back-to-back, the system easily adapts to available floor space;
- The small footprint of the cabinet and

PEAK SHAVING FUNCTION

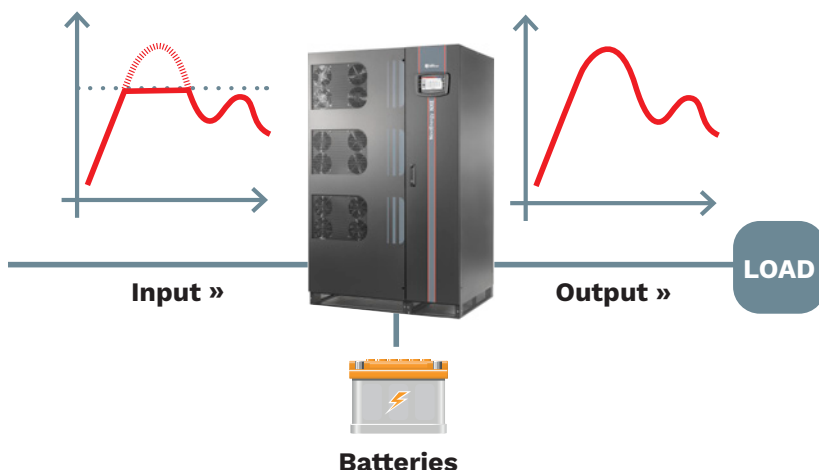

FLEXIBILITY OF POSITIONING

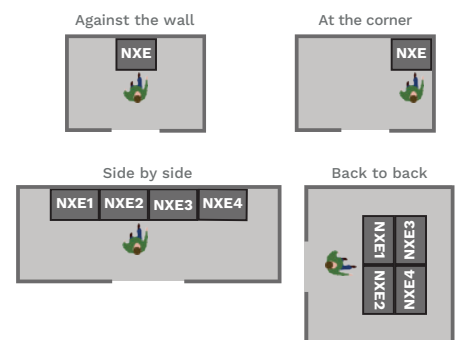

complete front access for all maintenance activities, ensures maximum space for installation and service;

- NextEnergy includes top and bottom cable entry (on NXE 250, NXE 500 and NXE 600 top on option);
- Operation without Neutral: NextEnergy can work with (4 wire) or without (3 wire) the neutral line connection (see below picture).



4-wire (L1-L2-L3-N) installation



3-wire (L1-L2-L3) installation

This is an important feature to reduce the TCO of the distribution system, where the neutral line cable is not distributed - savings investment - and the neutral is created by an isolation transformer close to the load.

This is a typical infrastructure solution adopted by modern Data Centre or for installations where the neutral is not used at all, allowing not only reduced cost for the distribution arrangements but also effortless replacement of legacy equipments.

MAXIMUM RELIABILITY AND AVAILABILITY

The NextEnergy architecture and features deliver significant cost savings thanks to an easy adapting to new or existing installations without impacting power infrastructure. This is possible through scalability, granting minimized initial investment (CAPEX), adding power cores as business demands grow:

- **Parallel configuration up to 8 units**

NextEnergy UPS can be connected in parallel with up to 8 units to increase the capacity or add redundancy (N+1). Parallel configuration with common or separated battery is possible.

- **Efficiency Control Mode (ECM)**

Considering that a typical UPS load can vary from 20% to 80%, the ECM function optimises the operating efficiency of a parallel UPS configuration according to the power absorbed by the load: in case of low load, it sets some UPS in “freeze” mode, ensuring redundancy and a working point of the “live” UPS in the higher efficiency working point, during all load conditions (see below picture).

- **Hot System Expansion (HSE)** allows the addition of further UPS into an existing system, without the need to switch off the operational units or transfer them to bypass mode.

OPERATION MODES

The UPS can operate in many Operation Modes, in order to grant always the maximum level of protection and maximum level of efficiency, based on mains quality and load type.

ON LINE

ON LINE Mode (Double Conversion) provides the highest level of power conditioning and protects the load from all electrical network disturbance in terms of voltage and frequency. The overall AC/AC efficiency is up to 97%.

ECO Mode

The load is normally powered from the bypass line while the rectifier keeps the battery charged. When the mains exceeds the limits the load is automatically transferred in ON LINE Mode in approx. 2 msec. The efficiency is more than 99%.



EFFICIENCY CONTROL MODE (ECM)

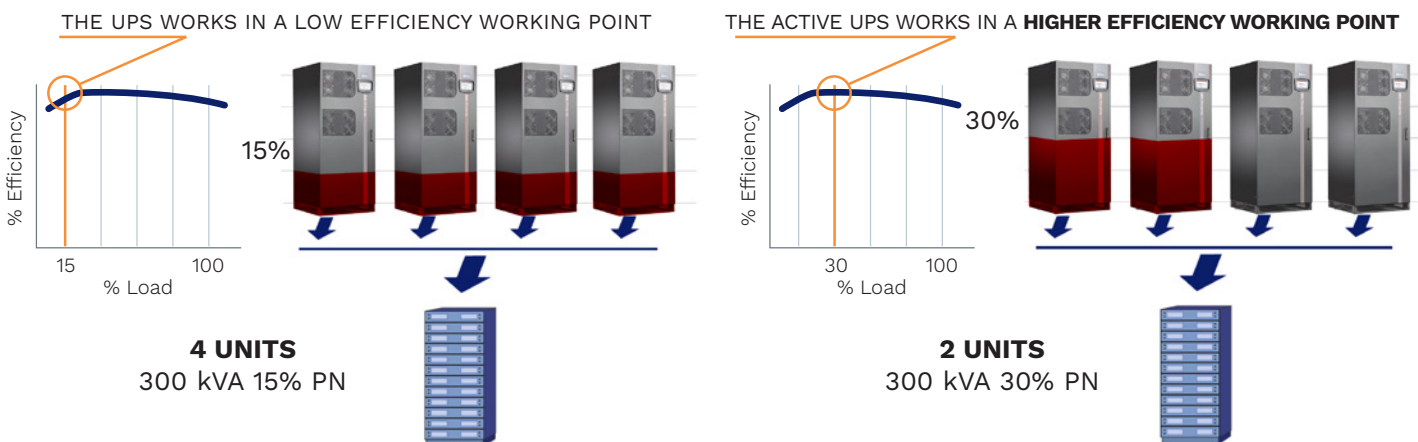

ACTIVE ECO

In this mode the NXE works as Active Filter: the bypass line is the priory source and supplies the active power while the inverter only provides the reactive part of the load. This ensures that the UPS input power factor remains close to unity, regardless of the load power factor. In addition, the inverter operation reduces significantly the harmonic content (THDi)



Combine high levels of **AVAILABILITY** with reduced **CAPEX** and **OPEX**

Higher availability vs ECO mode

Highest level of efficiency for an excellent cost savings

No need for expensive PFC

(POWER FACTOR CORRECTION SYSTEMS)

Avoid upstream problems related to high THDi

applied to the mains supply. In case of mains failure the transfer time on Inverter is approximately 0 (classified VFD SS 111). Power factor correction plays an active role in reducing the installation's TCO: it means reduction of Joule losses and voltage drop, for an optimum sizing of electrical equipment such as power transformers, cables, busbars, switch and protection devices. The electric distribution is more efficient and stable. Also the current distortion (harmonics) generated by non-linear loads such as inverters, computers, drives and so on causes several problems in an electric system. It is important to reduce it. ACTIVE ECO Mode combines high level of availability with important CAPEX and OPEX reduction. The efficiency is more than 98.5%

SMART ACTIVE

NextEnergy automatically defines whether to operate in ON LINE and/or ECO Mode, this is selected by monitoring the performances of the bypass supply, if this remains stable for a defined period the system stays in ECO Mode otherwise in ON LINE Mode. In SMART ACTIVE operating mode, the NextEnergy is able to combine the superior availability of a double conversion (ON LINE) operating mode with the excellent energy cost savings of a high efficiency mode (ECO Mode) for a reduced total cost of ownership.

SMART CAPACITY TEST (SCT)

Thanks to the Smart Capacity Test (SCT) functionality (Load Test mode) the system can be tested onsite during the commissioning, before it is connected to the real load, without using costly temporary loads, cabling and breakers and without wasting energy from the power network. In this condition the UPS output supplies energy to the input in re-circulating mode. In this mode NextEnergy is low consuming, just the energy due the internal losses.

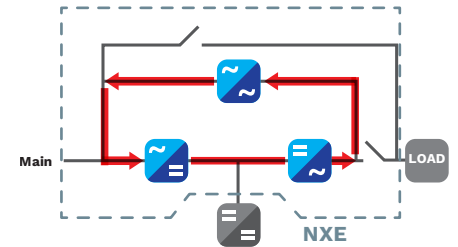

No need to use costly temporally loads, cabling and breakers. No waste of energy.

COLOUR LCD TOUCH SCREEN

Users can benefit from an advanced operation and supervision systems developed specifically for IT personnel, facilities managers and service engineers to ensure that the UPS setup, control and monitoring is easy. NextEnergy is equipped with an LCD touch screen 7" graphic display (800x480 pixels) providing in a user-friendly graphical interface the UPS information: line mimic diagram showing system status, dashboard style indicators for all the system values and conditions, voltage and current waveforms, operating states and alarms. The panel is used for configuration and setting the parameters of the UPS with high security access thanks to 3 separate password levels for users and service engineers.

OPERATION MODES

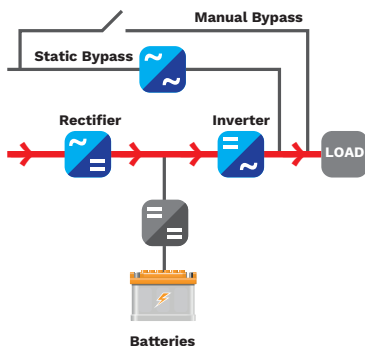

ON LINE

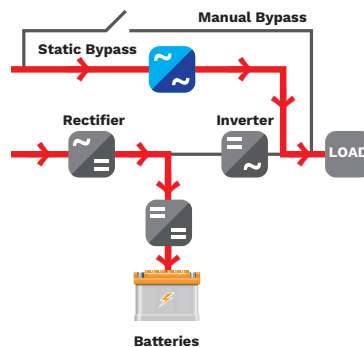

ECO Mode

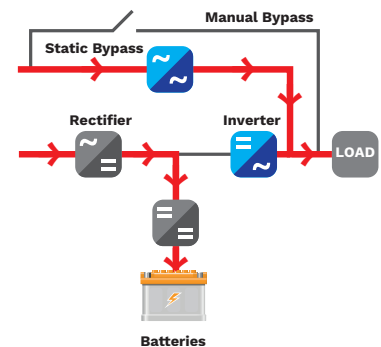

ACTIVE ECO (Active Filter)



The main features are:

- High security access with separate password levels for users, technician and service engineers;
- User-friendly graphical interface;
- Single-line mimic diagram showing system status;
- Contemporary dashboard-style indicators for major system values and conditions;
- Automatic charting display for logged power and environmental data.

ADVANCED COMMUNICATION AND SUPERVISION

NextEnergy offers wide communication and supervision tools and interface granting an easy integration into any building management system (BMS) and data centre infrastructure (DCIM).

- PowerShield³ monitoring and shutdown software for Windows operating systems 7, 8, 10; Hyper-V 2019, 2016, 2012 and previous versions; Mac OS X; Linux; VMWare ESXi; Citrix XenServer and many other Unix operating systems;

- PowerNetGuard and Riello Connect for remote monitoring service;
- 2 slots suitable for the installation of the communication accessories such as network adapters and BMS interface;
- Ethernet and USB ports;
- Relay cards with customized alarms and commands.

More and more applications require the use of lithium batteries that are always paired with Battery Monitoring Systems: for this reason, NextEnergy series offers an advanced interfacing system to easily dialogue with this kind of systems.

DETAILS

NXE 250
(open front)

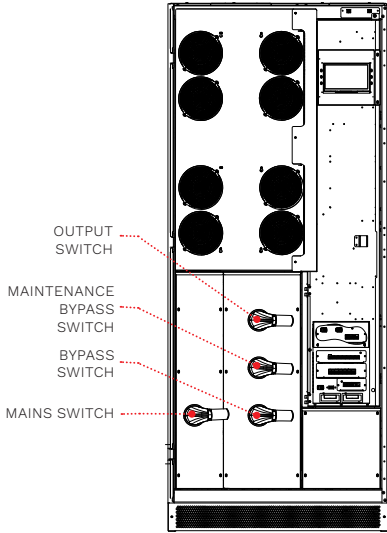

NXE 300
(open front)

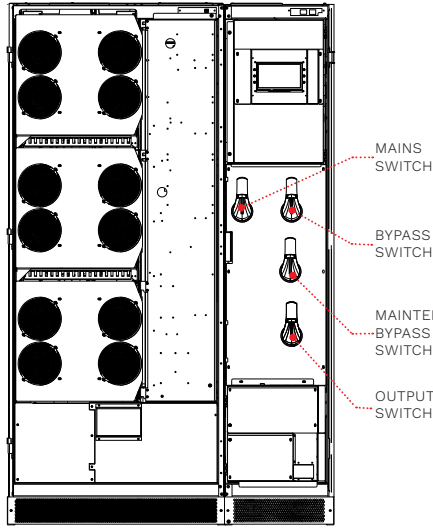

NXE 400
(open front)

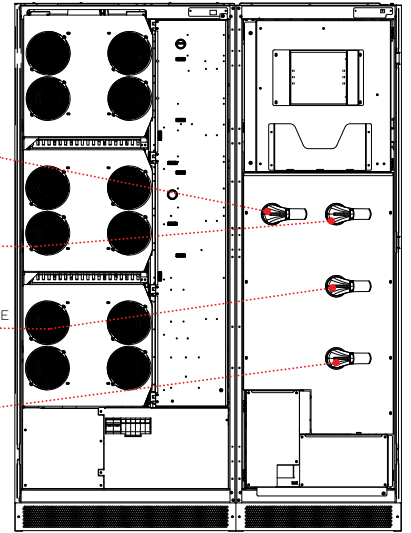

NXE 500
(open front)

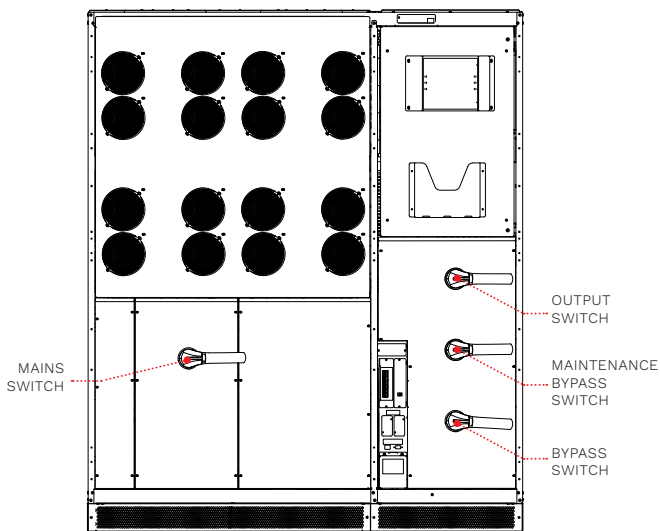

NXE 600
(open front)

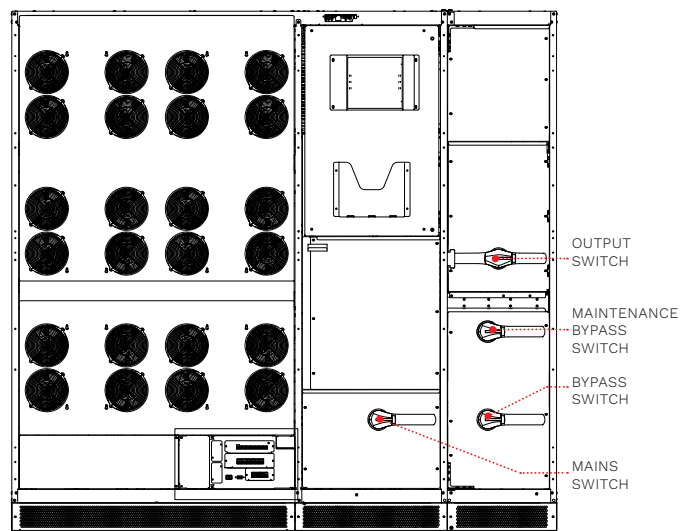

DETAILS

**NXE 800
(open front)**

**NXE 800 2SW
(open front)**

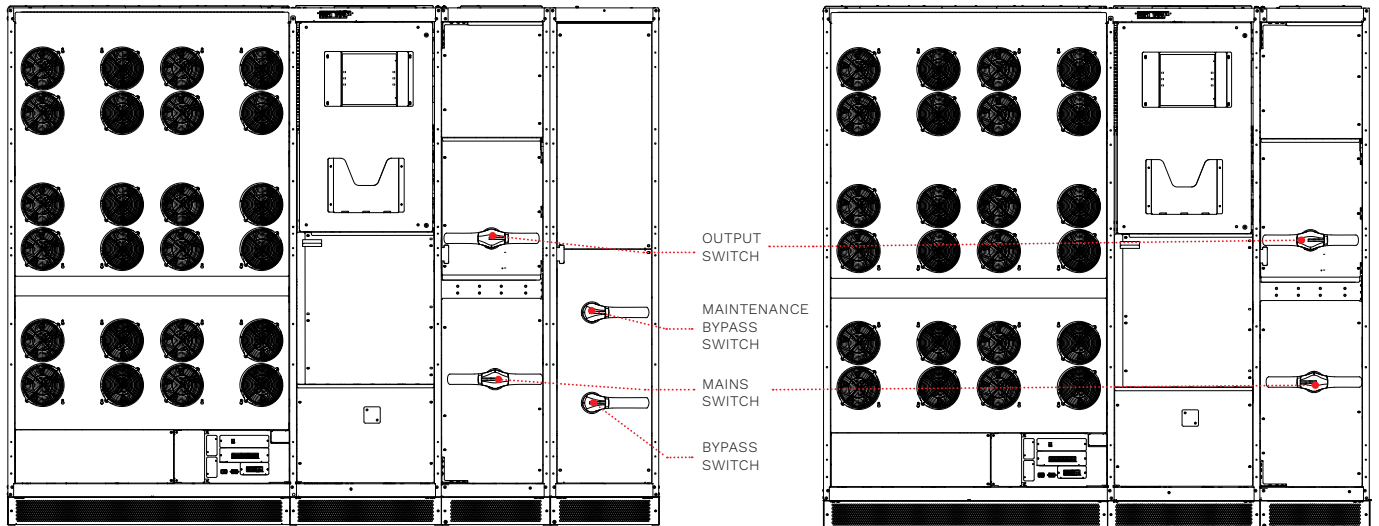

DIMENSION

NXE 250

NXE 300

NXE 400

NXE 500

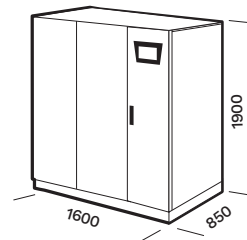
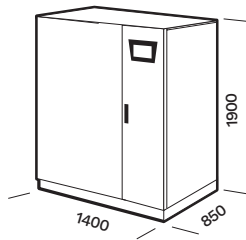
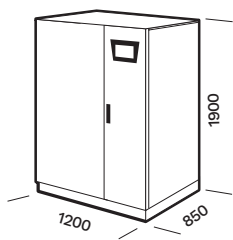
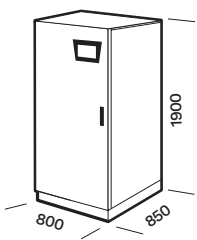

**NXE 600
NXE 800 2SW**

NXE 800

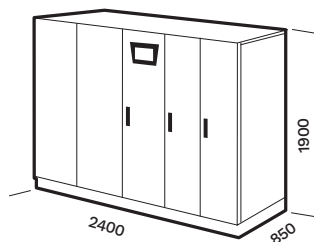
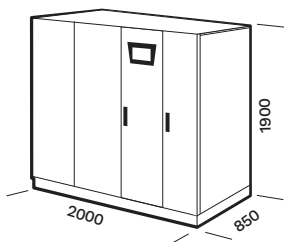

OPTIONS

SOFTWARE

PowerShield³
PowerNetGuard

ACCESSORIES

NETMAN 204
MULTICOM 302
MULTICOM 352
MULTICOM 411
MULTICOM 421

MULTI I/O

MULTI PANEL

EnergyManager

PRODUCT ACCESSORIES

Battery temperature sensor

Isolation transformer

Parallel configuration kit

Synchronisation device (UGS)

Hot connection device (PSJ)

Battery cabinets empty or for extended runtimes

IP21/IP31 versions, other on request

Cold start: to start the UPS from battery without mains

BATTERY CABINET

MODELS

UPS MODELS

BB 1900 480-V6 / BB 1900 480-V7
BB 1900 480-V8 / BB 1900 480-V9

NXE 250-300-400-500-600-800

Dimensions
[mm]

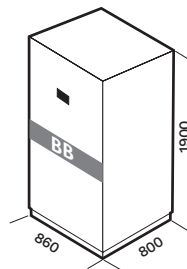

THREE-PHASE ISOLATION TRANSFORMERS

MODELS

UPS MODELS

TBX 200 T - TBX 250 T

NXE 250

TBX 300 T - TBX 400 T
TBX 500 T - TBX 600 T

NXE 300-400-500-600

Dimensions
[mm]

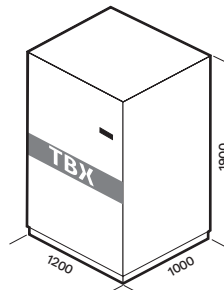
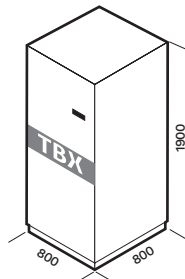

MODELS	NXE 250	NXE 300	NXE 400
INPUT			
Rated voltage [V]	380 / 400 / 415 three-phase		
Voltage tolerance [V]	400 ±20% @ full load ¹		
Frequency tolerance [Hz]	40 - 70		
Power factor	0.99		
THDI	<3%		
Soft Start	0 - 100% in 120 sec. (selectable)		
Standard equipment provided	Back feed protection, separate bypass line		
BATTERIES			
Type	VRLA AGM / GEL, NiCd, Supercaps, Li-ion, Flywheels		
Ripple current	Zero		
Recharge voltage compensation	-0.11% x V x °C		
OUTPUT			
Nominal Power [kVA]	250	300	400
Active Power [kW]	250	300	400
Number of phases	3 + N		
Rated voltage [V]	380 / 400 / 415 three-phase + N (selectable)		
Static Stability	±1%		
Dynamic Stability	±5% in 10 msec.		
Voltage distortion	<1% with linear load/<3% with non-linear load		
Frequency stability on battery	± 0.05%		
Frequency [Hz]	50 or 60 (selectable)		
Overload	110% for 60 min.; 125% for 2 min.; 150% for 20 sec.	110% for 60 min.; 125% for 10 min.; 150% for 1 min.	
BYPASS			
Rated voltage [V]	380 / 400 / 415 three-phase + N		
Rated Frequency [Hz]	50 or 60 (selectable)		
Frequency tolerance	±2% (selectable from ±1% to ±5%)		
OVERALL SPECIFICATIONS			
Weight [kg]	634	880	1100
Dimension (WxDxH) [mm]	800x850x1900	1200x850x1900	1400x850x1900
Input cable	Bottom	Top and bottom	Top and bottom
Remote signals	Volt-free contact (configurable)		
Remote controls	EPO, bypass battery charge block (configurable)		
Communications	USB + Dry contacts + 2 slots for communications interface		
Ambient temperature for the UPS	0 °C - +40 °C		
Recommended temperature for battery life	+20 °C - +25 °C		
Range of relative humidity	5-95% non-condensing		
Colour	Dark grey RAL 7016		
IP rating	IP20 (other on request)		
Efficiency (AC-AC) – ON LINE Mode	up to 97%		
Standards	European directives: L V 2014/35/EU low voltage Directive EMC 2014/30/EU electromagnetic compatibility Directive Standards: Safety IEC EN 62040-1; EMC IEC EN 62040-2; RoHS compliant Classification in accordance with IEC 62040-3 (Voltage frequency Independent) VFI - SS - 111		
Classification in accordance with IEC 62040-3	(Voltage Frequency Independent) VFI - SS - 111		
Moving the UPS	Pallet jack		

¹ For wider tolerance conditions apply.

MODELS	NXE 500	NXE 600	NXE 800 2SW	NXE 800
INPUT				
Rated voltage [V]	380 / 400 / 415 three-phase			
Voltage tolerance [V]	400 ±20% @ full load ¹			
Frequency tolerance [Hz]	40 - 70			
Power factor	0.99			
THDI	<3%			
Soft Start	0 - 100% in 120 sec. (selectable)			
Standard equipment provided	Back feed protection, separate bypass line			
BATTERIES				
Type	VRLA AGM / GEL, NiCd, Supercaps, Li-ion, Flywheels			
Ripple current	Zero			
Recharge voltage compensation	-0.11% x V x °C			
OUTPUT				
Nominal Power [kVA]	500	600	800	800
Active Power [kW]	500	600	800	800
Number of phases	3 + N			
Rated voltage [V]	380 / 400 / 415 three-phase + N (selectable)			
Static Stability	±1%			
Dynamic Stability	±5% in 10 msec.			
Voltage distortion	<1% with linear load/<3% with non-linear load			
Frequency stability on battery	± 0.05%			
Frequency [Hz]	50 or 60 (selectable)			
Overload	110% for 60 min.; 125% for 2 min.; 150% for 20 sec.		110% for 60 min.; 125% for 10 min.; 150% for 1 min.	
BYPASS				
Rated voltage [V]	380 / 400 / 415 three-phase + N			
Rated Frequency [Hz]	50 or 60 (selectable)			
Frequency tolerance	±2% (selectable from ±1% to ±5%)			
OVERALL SPECIFICATIONS				
Weight [kg]	1300	1600	1800	1985
Dimension (WxDxH) [mm]	1600x850x1900	2000x850x1900	2000x850x1900	2400x850x1900
Input cable	Bottom	Bottom	Bottom	Top and bottom
Remote signals	Volt-free contact (configurable)			
Remote controls	EPO, bypass battery charge block (configurable)			
Communications	USB + Dry contacts + 2 slots for communications interface			
Ambient temperature for the UPS	0 °C - +40 °C			
Recommended temperature for battery life	+20 °C - +25 °C			
Range of relative humidity	5-95% non-condensing			
Colour	Dark grey RAL 7016			
IP rating	IP20 (other on request)			
Efficiency (AC-AC) – ON LINE Mode	up to 97%			
Standards	European directives: L V 2014/35/EU low voltage Directive EMC 2014/30/EU electromagnetic compatibility Directive Standards: Safety IEC EN 62040-1; EMC IEC EN 62040-2; RoHS compliant Classification in accordance with IEC 62040-3 (Voltage frequency Independent) VFI - SS - 111			
Classification in accordance with IEC 62040-3	(Voltage Frequency Independent) VFI - SS - 111			
Moving the UPS	Pallet jack			

¹ For wider tolerance conditions apply.

NXE EMBEDDED PROTOCOLS

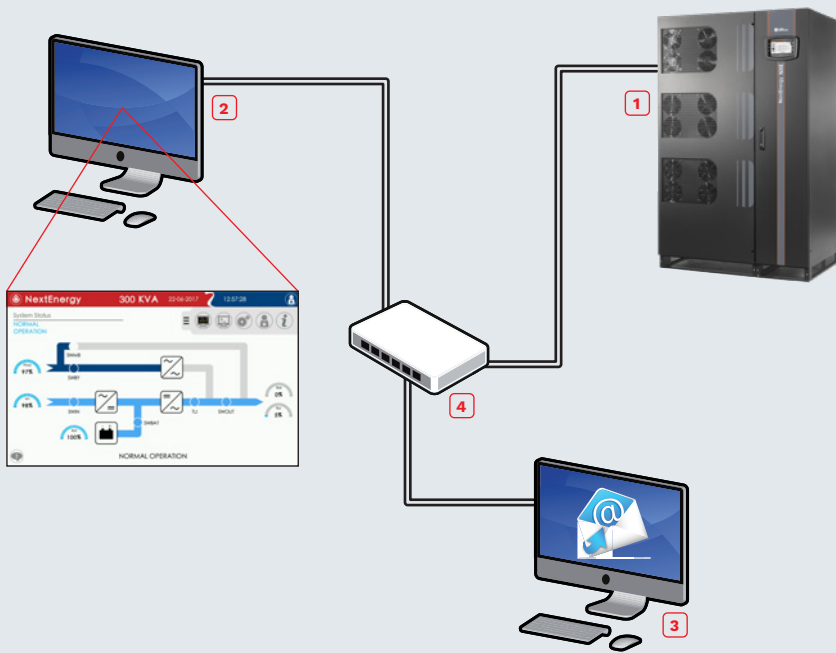

- 1 NextEnergy UPS
- 2 PowerShield³
- 3 Mail Server
- 4 Ethernet Switch
- == Ethernet

NXE PROTOCOLS ADDING NETMAN 204 CARD

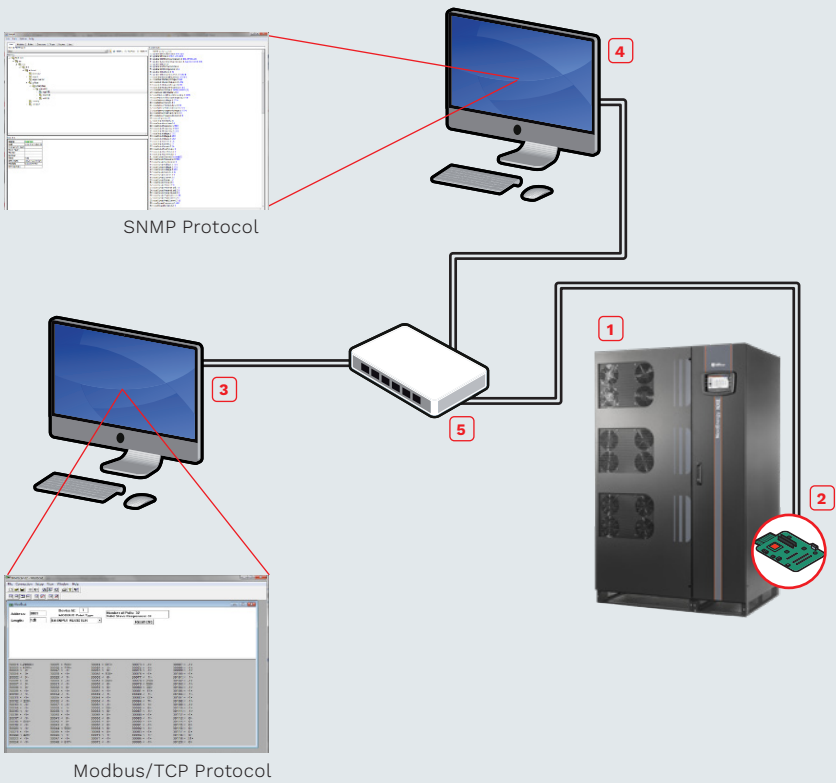

- 1 NextEnergy UPS
- 2 NetMan 204 board
- 3 Modbus/TCP Manager
- 4 SNMP Manager
- 5 Ethernet Switch
- == Ethernet

RPS S.p.A.

ITALY

LEGNAGO (VR) Head Office

Viale Europa, 7
37045 LEGNAGO (Verona)
Tel +39 0442 635811

CORMANO (MI) Sales Office

Via Somalia, 20
20032 CORMANO (Milano)
Tel +39 02 663271

Visit www.riello-ups.com/bases
for contact details.

WORLDWIDE SUBSIDIARY COMPANIES

USA

RPS America, Inc.

8808 Beckett Rd
West Chester, OH 45069

UNITED KINGDOM

RIELLO UPS Ltd.

Unit 50 Clywedog Road North
Wrexham Industrial Estate
Wrexham LL13 9XN

CONSTANT POWER SERVICES Ltd.

Riello House, Works Road,
Letchworth
SG6 1AZ Hertfordshire

GERMANY

RIELLO UPS GmbH

Wilhelm-Bergner-Str. 9b
21509 Glinde

RIELLO POWER SYSTEMS GmbH

Neufahrner Str. 12b
85375 Neufahrn/Grüneck

FRANCE

RIELLO ONDULEURS S.a.r.l.

4 Rue du Bois Chaland,
ZAC du Bois Chaland
91090 Lisses

SPAIN

RIELLO ENERDATA s.l.

C/ Labradoros, 11
Parque Empresarial
Prado del Espino
28660 Boadilla del Monte
Madrid

RIELLO TDL s.l.

C/Berguedà, 6 bis
Pol. Ind. Plà de la Bruguera
08211 Castellar del Vallès, Barcelona

ROMANIA

RIELLO UPS ROMANIA S.r.l.

Str. Varsovia Nr. 4
307160 Dumbravita
Timis County - Romania

POLAND

RIELLO DELTA POWER Sp. z o.o.

ul. Krasnowolska 82 R
02-849 Warszawa

AUSTRALIA

RIELLO UPS AUSTRALIA Pty. Ltd.

Unit 4, 60-68 Box Road
Taren Point - Sydney

ASIA PACIFIC

RIELLO UPS SINGAPORE Pte Ltd.

No. 506 Chai Chee Lane,
#07-01, Singapore 469026

CHINA

RIELLO UPS (Asia) Co., Ltd.

Room 102, building 12,
no. 535 Shennan Road,
Minhang district,
201108, Shanghai P.R. of China

INDIA

RIELLO POWER INDIA Pvt. Ltd.

Plot no. 213A, Sector-4,
IMT Manesar, 122050 Gurgaon (HR)

ARABIAN PENINSULA

RIELLO UPS Middle East FZ-LLC

Dubai Science Park
North Tower, 8th Floor, Office 801N
Al Barsha South, 500767

